



imes-icore[®]
Dental & Medical Solutions



CORiTEC[®] 150i series

The CORiTEC® 150i series



CORiTEC 150i PRO

CORiTEC 150i dry

WHAT ARE THE DIFFERENCES?

PC	integrated	integrated
Touchscreen	✓	✓
Integrated PC	✓	✓
Premilled Abutments	✓ (CoCr/Ti)	✓ (CoCr)
Wet processing	✓	-
Dry processing	✓	✓
Metal processing*	✓	✓
Integrated water tank	✓	-
Ionizer	✓	✓
Auto-calibration	✓	✓
Automated cleaning function	✓	✓
Chip tray	-	✓
98mm blank holder	✓	✓
6-fold glass ceramic holder	Optional	-
Half-open blank holder "C-Clamp"	Optional	Optional

*limited metal processing (blank)



VERSATILE IN
all cases

Features



Minimum compressed air requirement



Integrated ionizer



Auto-calibration



Automated cleaning function



Large number of holder systems



Metal processing*

WHETHER WET OR DRY MACHINING, BLOCK OR BLANK FORM, THE CORiTEC 150i SERIES IMPRESSES IN ALL AREAS.



Each restoration is fabricated with optimum precision and, at the same time, the flexibility opens up an almost free choice of materials and indications. Milling and grinding of zirconium, plastics and metal** is possible, as is the machining of CAD/CAM blocks and Pre-milled abutments. The CORiTEC 150i offers an unrivalled variety of applications in a very small space.

UNLIMITED FLEXIBILITY IN MILLING AND GRINDING – THAT'S THE PROMISE OF THE CORiTEC 150i SERIES



Thanks to a machining angle of up to 360°/130° (A-axis/B-axis), the system is able to effortlessly master even the most demanding tasks. The 10 tool places additionally increase the flexibility of the new CORiTEC 150i series.

*Limited metal processing (blank)



Features

MORE PERFORMANCE,
MAXIMUM FLEXIBILITY AND
EXTENDED APPLICATION
POSSIBILITIES WITH MINIMAL
SPACE REQUIREMENTS

An exceptional ratio of power, speed and precision – this is what the powerful high-frequency spindle with 860 W and 100.000 rpm offers. Thanks to the quick-clamping system, the various holder systems can be changed quickly and easily – while maintaining the same precision. Time-consuming calibrations are therefore unnecessary.



A VARIETY OF
HOLDING SYSTEMS
OFFERS MAXIMUM
FLEXIBILITY FOR
MAXIMUM CHALLENGES

Also new is the support of the half-open blank holder, the so-called "C-Clamp". Thanks to its open shape, it allows even the most difficult indications to be produced.



ION



CORiTEC® 150i PRO

THE FLEXIBLE MILLING SYSTEM IN CONFINED SPACES

The extremely stable design of the mono-block cast body enables precise machining with round blanks and block forms. The machine's small dimensions and 5-axis simultaneous technology offers a unique ratio of machine size and functionality. Convince yourself of the performance of the CORiTEC 150i for your laboratory!

Available in two versions:



CORiTEC 150i PRO



CORiTEC 150i dry

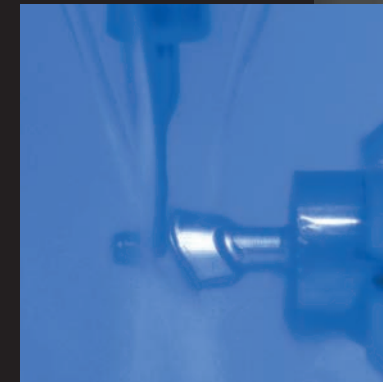
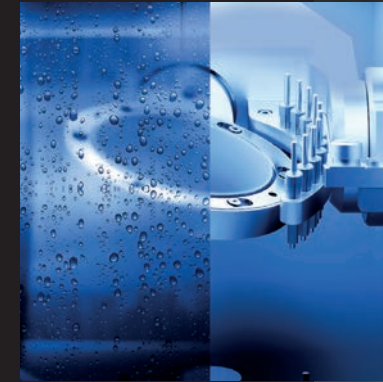

- WET
- DRY
- 5 AX
- 3 mm / 10x
- Temperature control icon
- Touch screen icon
- Material tray icon
- Blank icon
- ION

CORiTEC® 150i PRO

HIGHLIGHTS

- Novel, closed mono-block cast body for highest stability and precision
- No external PC required
- Half-open blank holder "C-Clamp" (optional)
- Ionizer inclusive
- High precision due to integrated temperature compensation
- Wet and dry machining possible
- Minimum external compressed air, only 3 bar required
- Short amortization period
- Minimal footprint
- Auto-calibration
- Automated cleaning function
- Metal processing*
- Turn-milling-grinding-processing possible

*Limited metal processing (blank)



PMMA	WAX	Standard	PreMilled Abutment	Dentures	Crown, Bridge	Inlay, Onlay Veneer	Hybrid Abutment	Splint
Zr	COMPOSITE							
PEEK	SINT	C-Clamp	Block	Manual clamping system	Full Denture	Model	Drilling template	Model casting
Glass-ceramics	PreFab Abutments							
CoCr	Ti				Bridge	Telescopic technology	Abutment	Hybrid machining

T1/T6 - 3.0 | 3.0 mm
radius milling tool (l = 15 mm)

T1	Ti
T6	CoCr

3.0 mm Ø 3 mm

up to 15 mm

Blades

Art.-No. 530029 3003

T11/T13 - 2.5 | 3.0 mm
radius milling tool

T11	PMMA
T13	WAX Zr

2.5 mm Ø 3 mm

up to 25 mm

Blades

Art.-No. 530016 2503

T16 - 1.5 | 3.0 mm
radius milling tool (l = 15 mm)

T16	PMMA WAX Zr
-----	-------------------

1.5 mm Ø 3 mm

up to 15 mm

Blades

Art.-No. 530016 1503

T24 - 1.5 | 3.0 mm
radius grinding tool (diamond)

T24	glass ceramics
-----	-------------------

1.5 mm Ø 3 mm

Blades

Art.-No. 530005 1503

T2/T7 - 2.0 | 3.0 mm
radius milling tool (l = 12 mm)

T2	Ti
T7	CoCr

2.0 mm Ø 3 mm

up to 15 mm

Blades

Art.-No. 530029 2003

T12 - 1.0 | 3.0 mm
radius milling tool (single blade, slide coated)

T12	PMMA WAX PEEK
-----	---------------------

1.0 mm Ø 3 mm

up to 25 mm

Blade

Art.-No. 530004 1003

T19 - 0.5 | 3.0 mm
shaft milling tool (l = 4 mm), universal

T19	UNIVERSAL
-----	-----------

0.5 mm Ø 3 mm

up to 15 mm

Blades

Art.-No. 530001 0503

T31 - 3.0 | 3.0 mm
shaft milling tool (single blade, slide coated)

T31	PMMA WAX Zr
-----	-------------------

3.0 mm Ø 3 mm

up to 30 mm

Blade

Art.-No. 530012 3003

T3/T8 - 1.5 | 3.0 mm
radius milling tool (l = 12 mm)

T3	Ti
T8	CoCr

1.5 mm Ø 3 mm

up to 15 mm

Blades

Art.-No. 530029 1503

T12/T14 - 1.0 | 3.0 mm
radius milling tool

T12	PMMA WAX
T14	Zr

1.0 mm Ø 3 mm

up to 25 mm

Blades

Art.-No. 530016 1003

T20 - 0.6 | 3.0 mm
radius milling tool (conical)

T20	Ti CoCr
-----	------------

0.6 mm Ø 3 mm

up to 15 mm

Blades

Art.-No. 530003 0603

T32 - 0.6 | 3.0 mm
radius milling tool long (l = 12 mm)

T32	PMMA WAX Zr
-----	-------------------

0.6 mm Ø 3 mm

up to 25 mm

Blades

Art.-No. 530012 0603

T4/T9 - 1.0 | 3.0 mm
radius milling tool (l = 9 mm)

T4	Ti
T9	CoCr

1.0 mm Ø 3 mm

up to 15 mm

Blades

Art.-No. 530029 1003

T13/T40/T50 - 2.5 | 3.0 mm
radius milling tool (diamond coated)

T13	Zr
T40	SINT
T50	COMP

2.5 mm Ø 3 mm

up to 25 mm

Blades

Art.-No. 530013 2503

T21 - 2.5 | 3.0 mm
radius grinding tool (diamond)

T21	glass ceramics
-----	-------------------

2.5 mm Ø 3 mm

Blades

Art.-No. 530005 2503

T33/T43/T53 - 0.3 | 3.0 mm
radius milling tool (conical)

T33	PMMA WAX Zr
T43	SINT
T53	COMP

0.3 mm Ø 3 mm

up to 25 mm

Blades

Art.-No. 530016 0303

T5/T10/T17 - 1.5 | 3.0 mm
shaft milling tool (l = 15 mm), universal

T5	Ti
T10	CoCr
T17	PMMA WAX Zr

1.5 mm Ø 3 mm

up to 25 mm

Blades

Art.-No. 530001 1503

T14/T41/T51 - 1.0 | 3.0 mm
radius milling tool (diamond coated)

T14	Zr
T41	SINT
T51	COMP

1.0 mm Ø 3 mm

up to 25 mm

Blades

Art.-No. 530013 1003

T22 - 1.0 | 3.0 mm
radius grinding tool (diamond)

T22	glass ceramics
-----	-------------------

1.0 mm Ø 3 mm

Blades

Art.-No. 530005 1003

T59 - 0.6 | 3.0 mm
highspeed, 15mm

T59	CoCr
-----	------

1.5 mm Ø 3 mm

up to 15 mm

Blades

Art.-No. 530031 2003

T11 - 2.5 | 3.0 mm
radius milling tool (single blade, slide coated)

T11	PMMA WAX PEEK
-----	---------------------

2.5 mm Ø 3 mm

up to 25 mm

Blade

Art.-No. 530004 2503

T15/T42/T52 - 0.6 | 3.0 mm
radius milling tool (conical)

T15	PMMA WAX Zr
T42	SINT
T52	COMP

0.6 mm Ø 3 mm

up to 25 mm

Blades

Art.-No. 526016 0603

T23 - 0.6 | 3.0 mm
radius grinding tool (conical, diamond)

T23	glass ceramics
-----	-------------------

0.6 mm Ø 3 mm

Blades

Art.-No. 530005 0603

T98 - 2.5 | 3.0 mm
shaft milling tool (l = 20 mm, three blades)

T98	CALIBR.
-----	---------

2.5 mm Ø 3 mm

Blades

Art.-No. 530024 2503

Materials

priti® MULTIDISC (ZIRCONIUM DIOXIDE)

High-end zirconia for highest mechanical and aesthetic demands. Indications up to 16-unit bridges, max. 3-unit bridges only with High Translucent.

Wide range of colors and heights available.

	Translucence	Strength
Multi Translucent	49-40 %	80 - 1150 MPa
High Translucent	49 %	> 650 MPa
Extra Translucent	45 %	> 1150 MPa
Translucent	40 %	> 1150 MPa
Opaque	35 %	> 1150 MPa



CORTEC NEM (NON-PRECIOUS METALS)

Burn-on non-precious metal dental milling alloys for the fabrication of e.g. up to 16-unit bridges, implant-supported superstructures etc.

CORTEC NEM is characterized by excellent mechanical properties and good machinability.



CoCr M6 disc

molybdenum containing
type 4 alloy (EN ISO 22674)



CoCr W8 disc

tungsten containing
type 4 alloy (EN ISO 22674)

Scan yourself to priti@multidisc
and CORTEC materials!
www.pritidenta.com



CORTEC SPLINT COMFORT POLYMERS

Extremely comfortable and biocompatible material for the fabrication of therapeutic splints such as occlusal or stabilization splints. For maximum comfort it becomes more flexible at mouth temperature.

Available in 16 mm and 20 mm.



CORTEC SPLINT BASIC POLYMERS

Crystal clear material for the fabrication of therapeutic splints and drilling templates. Good machinability.

Available in 16 mm and 20 mm.



CORTEC TEMP PMMA DISC

An excellent material to work with that is suitable for long-term temporaries with up to three years of wear and that also contains intrinsic color gradients.

Available in 8 vita shades in 16 mm and 20 mm.



CORTEC GUM PMMA DISC

For gingiva replacement, available in 25 mm.



CORiTEC® SmartControl™

SMART CONTROL OF MACHINE SOFTWARE

SmartControl™: one touch ahead!

The newly developed control software SmartControl™ enables absolutely intuitive operation of our milling machines. From selecting the job to milling or querying the machine status; the self-explanatory and optimized handling makes it possible to start operating the machine in the shortest possible time. Starting a milling process requires only two clicks – you benefit from the smart time savings for your workflow!

FEATURES

- Modern design and simple touch operation
- Intelligent selection of milling jobs
- Easy tool and material loading
- Auto-calibration of the machine
- Wizard guided cleaning and maintenance
- Connection to the Dental Smart Market (DSM)
- Multilingual program interface
- Automatic update function

Optimized for touchscreen operation

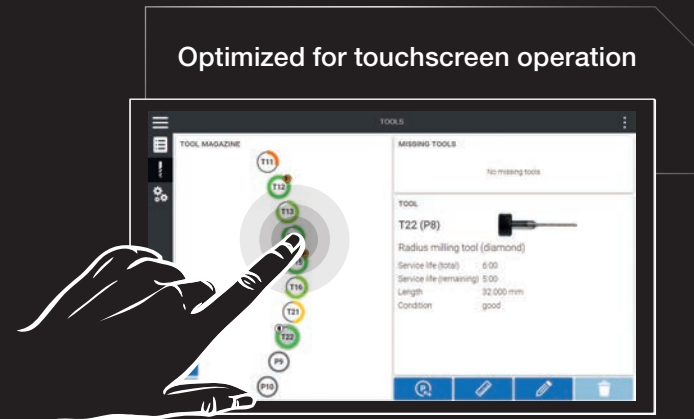

Automated transfer of information from the CAM software

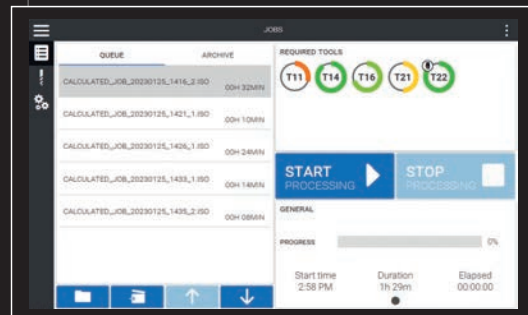

Ideal tool management

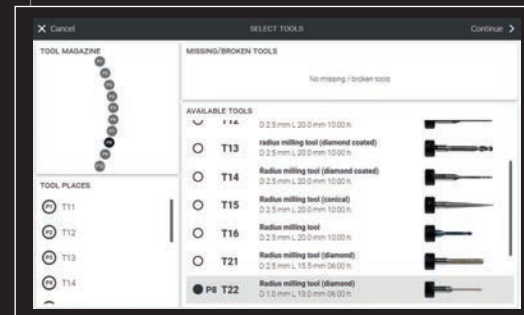

Scanner COMPATIBLE WITH exocad

CORiTEC i3Dscan color

- Automatic object guidance into the measuring field
- Modern touch-operation design
- The 180-degree opening offers a large working area

CORiTEC i3Dscan color HR

- Enormously high scanning efficiency and precision (4 µm)
- Color texture scan
- Blue-Light LED & high resolution camera (2.8 MP)
- All modules included in the scope of delivery



CAM software

CORiTEC iCAM V5 smart

- All strategies optimized for 5-axis simultaneous machining
- Automatic exchange of implant connections (ReFit option)
- No annual license fees
- Fully automatic and easy operation with “Wizard Workflow“

CORiTEC iCAMHD

- hyperDENT based CAM software
- Flexible payment model (purchase or subscription model)

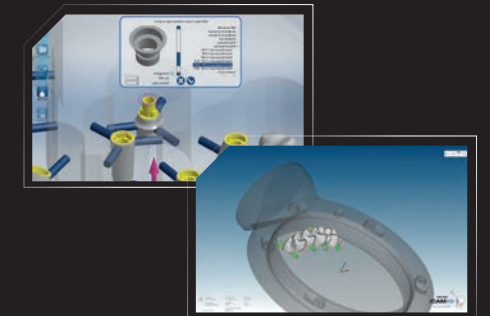

Auto-calibration

FAST, PRECISE, COST-EFFICIENT

Auto-calibration allows a quick and easy handling to ensure lasting precision without compromise.



Full integrated workflow

OPEN TO ALL COMMON SCANNERS

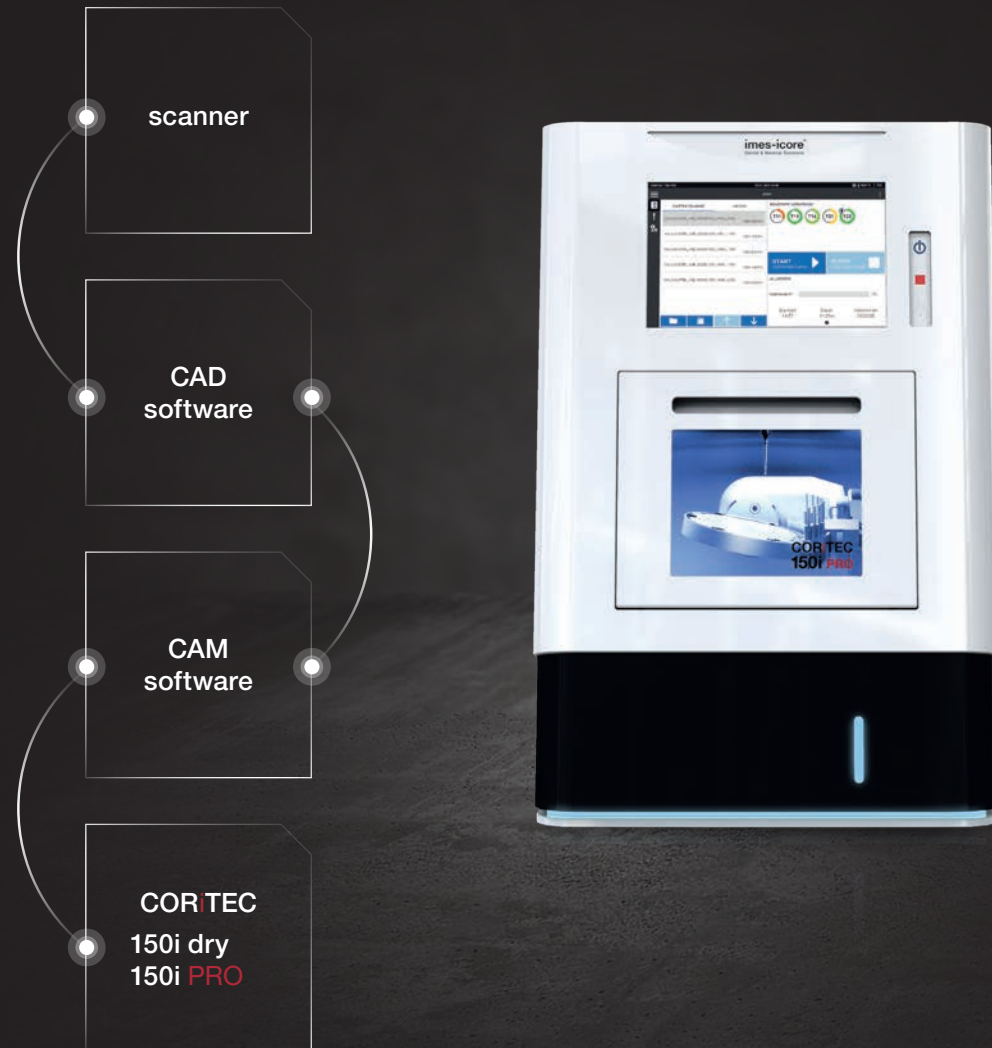

Applications & holders

HALF-OPEN BLANK HOLDER (C-CLAMP)

- Enables 5-axis machining up to 90 degrees axis adjustment
- Extension of the technical possibilities of your milling machine



UNIVERSAL HOLDER FOR TURN-MILL-GRINDING PROCESSING

- High precision
- Improved surface quality
- Tool-saving machining



PREFABRICATED ABUTMENTS

- Short production times
- Production of abutments in very simple processes
- High accuracy of fit due to prefabricated implant interface

DESS
Abutmentholder



NT-Preform® Abutment
(nt-trading)



PreFace® Abutment
(Medentika)



MED-Preform® Abutment
(medentis)

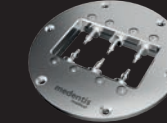

ELOS premilled
Abutment System



THERAPEUTIC SPLINTS

- Bite splints, bleaching splints
- Snoring splints, aligners
- Simple and high-quality implementation in CAD/CAM processes



GRINDING OF CAD/CAM BLOCKS

- New 6-fold adapter enables effective production
- Exchangeable strips for different adapter systems
- Crowns, onlays, inlays, veneers, bridge frameworks etc.



MILLING OF MODEL CASTS

- Production in burnout materials (PEEK)
- Allergy-free and lightweight model casting when using PEEK
- Cost-efficient

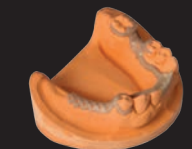

Sintering furnaces

iSINT eco

The iSINT eco offers high-quality technology as well as suitable accessories for high demands at a fair price. Compact and with a small footprint, the iSINT eco sintering oven still has sufficient capacity for a sintering bowl Ø100 mm for approx. 25 units. The door stop can be mounted at the right or left side.

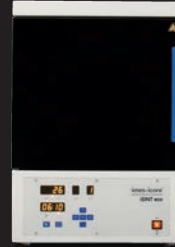

iSINT PRO

A larger sintering capacity of up to 80 single crowns is offered by the new iSINT PRO. With a heating system of four high-quality molybdenum disilicide (MoSi₂) heating elements, you can choose between conventional long-term sintering or SPEED sintering at a rate of up to 99 °C/min/210.20 °F/min. The iSINT PRO is operated with a simple and convenient program control. The programs are indicated on a 4-line LCD display. A timer function for overnight sintering or the use of pre-drying programs for shaded zirconium restorations offer further options. In addition, three service programs are available for easy maintenance of the sinter furnace.



	iSINT eco	iSINT PRO
Number of heating elements	4	4
Display	7-segment	4-line LCD
Number of program memories	9	30
Combustion chamber capacity	1 x 100	2 x 120
Max. heating rate	30 °C/min / 86 °F/min	99 °C/min / 210.20 °F/min
Power in W	1300	3200
Lift function	No	Yes
Speedsintering	No	Yes

Suction system

iVAC silent & iVAC silent PRO

The system is equipped with a teflon filter cartridge, automatic filter cleaning and a dust drawer. With the suction power of 160m³/h the iVAC silent is perfectly suited for your CORTEC 150i and is even stowable in the optional machine table.



	iVAC silent	iVAC silent PRO
Airflow	160 m ³ /hr	240 m ³ /hr
Power	490 W	1610 W
Filter system	Teflon filter cartridge, automatic cleaning feature	Teflon filter cartridge, automatic cleaning feature
Filter volume	8 liters/30.28 gpm (dust drawer)	8 liters/30.28 gpm (dust drawer)
Width x depth x height	9.6 x 19.6 x 17.3 inch / 245 x 500 x 440 mm	10.6 x 21.2 x 21.1 inch / 270 x 540 x 535 mm
Supply voltage	230 V	115 V/230 V
Special features	Suitable for machine tables T0, T1 and T2, quiet running, very compact, self-cleaning by vibration	Suitable for machine tables T1 and T2, quiet running, very compact, self-cleaning by vibration



Machine table

MACHINE TABLE T0

The machine table T0 is exactly adapted to the CORTEC 150i series by its dimensions 422 x 540 x 900 mm/16.6 x 21.3 x 35.4 inch (W x D x H).

Dimensions

CORiTEC® 150i series

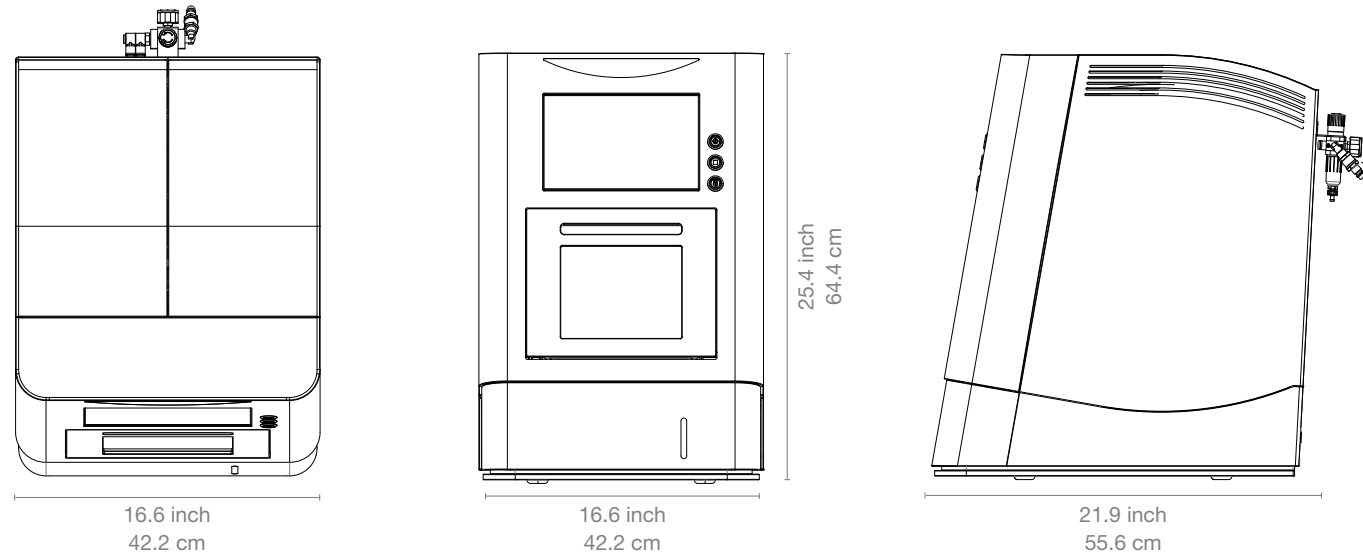

Machine table T0

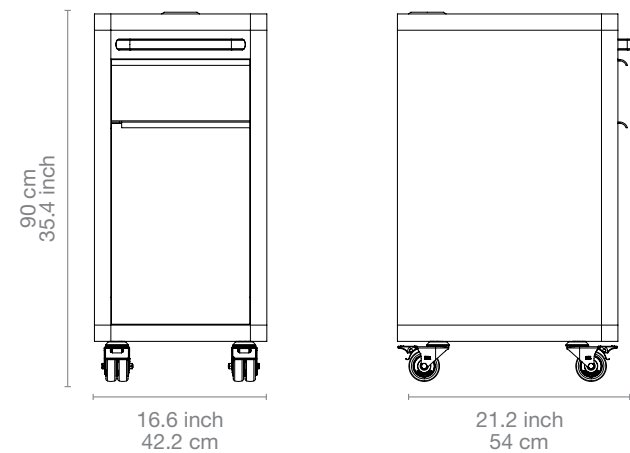

In numbers

Mechanics/electronics

Number of axes and operation type	5 axes, simultaneous processing
Rotation angle	A-axis 360°, B-axis 130°
Spindle / power	High-frequency spindle / 860 W
Maximum spindle speed	100.000 rpm
Tools	Hilling and grinding tools with 3 mm tool shaft
Tool changer	10-fold
Tool length control	≤ 0.002 mm precision
Integrated PC	Windows based
Monitor	Integrated 10"1" touchscreen
Illumination	Dynamic LED illumination
Software	SmartControl™ integrated CNC software
Air pressure	3 bar/43.5 PSI, 50l/min/189.25 gpm/min
Cooling liquid	3 liter/11.36 gpm integrated

Connecting requirements

Weight	75 kg / 165.38 lbs
Width x depth x height	16.6 x 21.9 x 25.4 inch / 422 x 556 x 644 mm
Line voltage/frequency	100 V - 240 V/50/60 Hz

Sales and support partner worldwide



Represented for you in over 100 countries.

imes-icore® GmbH has been a leading manufacturer and technology partner since 2003 in the field of dental CAD/CAM systems and solutions.

With its unique range of dental milling and grinding systems, imes-icore® offers a perfect selection for all individual requirements of dental laboratories, milling centres and dental practices of all sizes.

Our Open-System product philosophy makes it possible to easily integrate our milling machines into your existing workflow and to integrate them with your open scanners and your CAD/CAM software. We are open for your material selection.

imes-icore® GmbH

Fon +49 (0) 66 72/898 228

Fax +49 (0) 66 72/898 222

dental@imes-icore.com